

DRAWINGS

FOR

INTUITECH

FLOCCULATION & SEDIMENTATION MODULE

S09533224-10PC-2TU-2PH-4CF-1CM

FOR

INSTALLATION

RELEASE #1

JULY 8, 2025

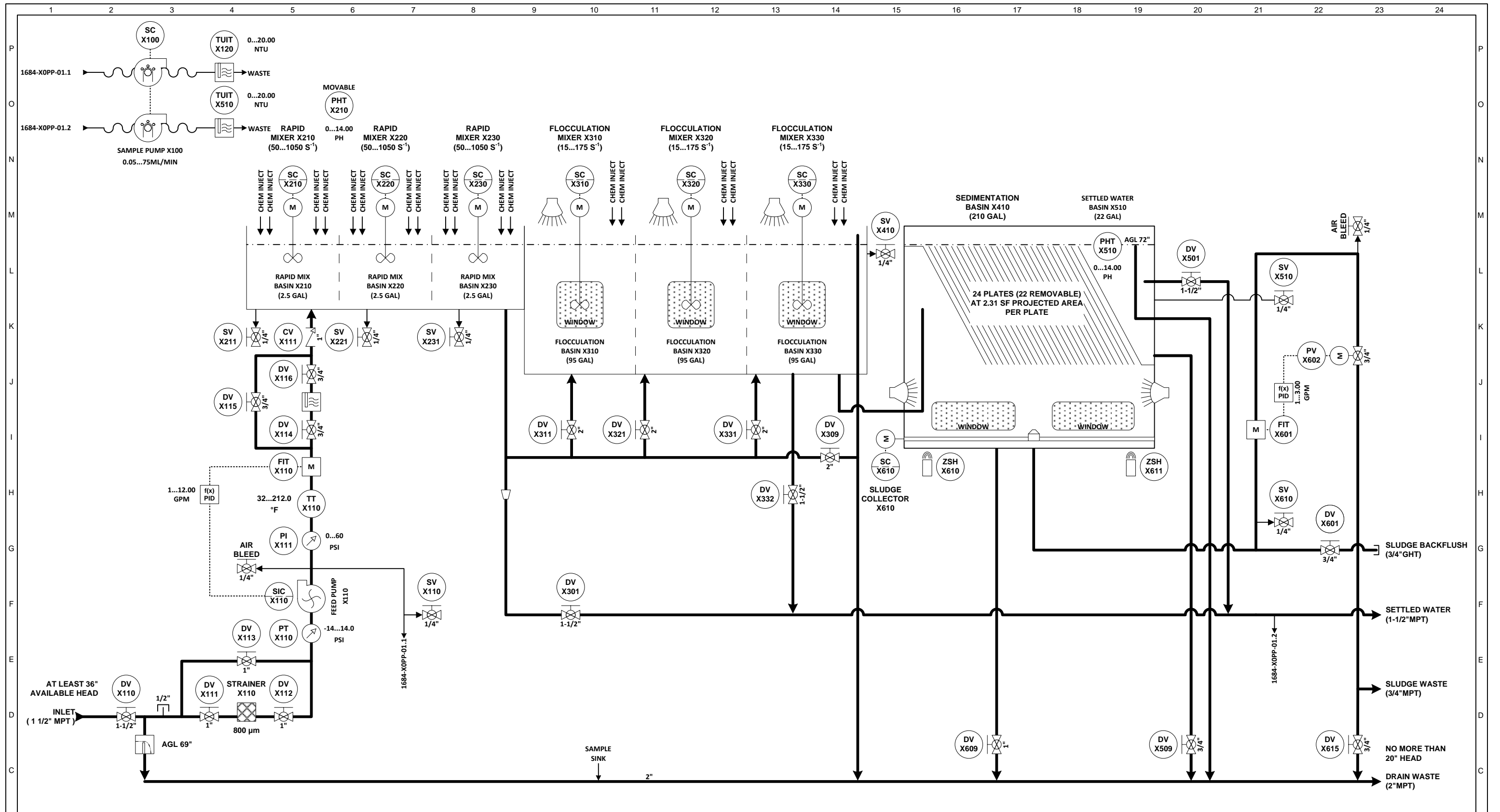

REV	DATE	BY	DESCRIPTION
1	03-15-21	AJB	MODIFIED DEVICE RANGES ON MIXERS & FLOW TRANSMITTERS, ADDED AGL'S
2			
3			
4			



www.intuitech.com

THIS DRAWING IS THE INTELLECTUAL PROPERTY OF INTUITECH AND MAY NOT BE REPRODUCED IN FULL OR IN PART FOR ANY PURPOSE ASIDE FROM THE PROJECT AS SPECIFIED ON THIS DOCUMENT

DIMENSIONAL TOLERANCES ARE AS FOLLOWS, UNLESS OTHERWISE SPECIFIED

FRAC: ± 1/16 0.XX: ± 0.01
 ANGLES: ± 1° 0.XXX: ± 0.005

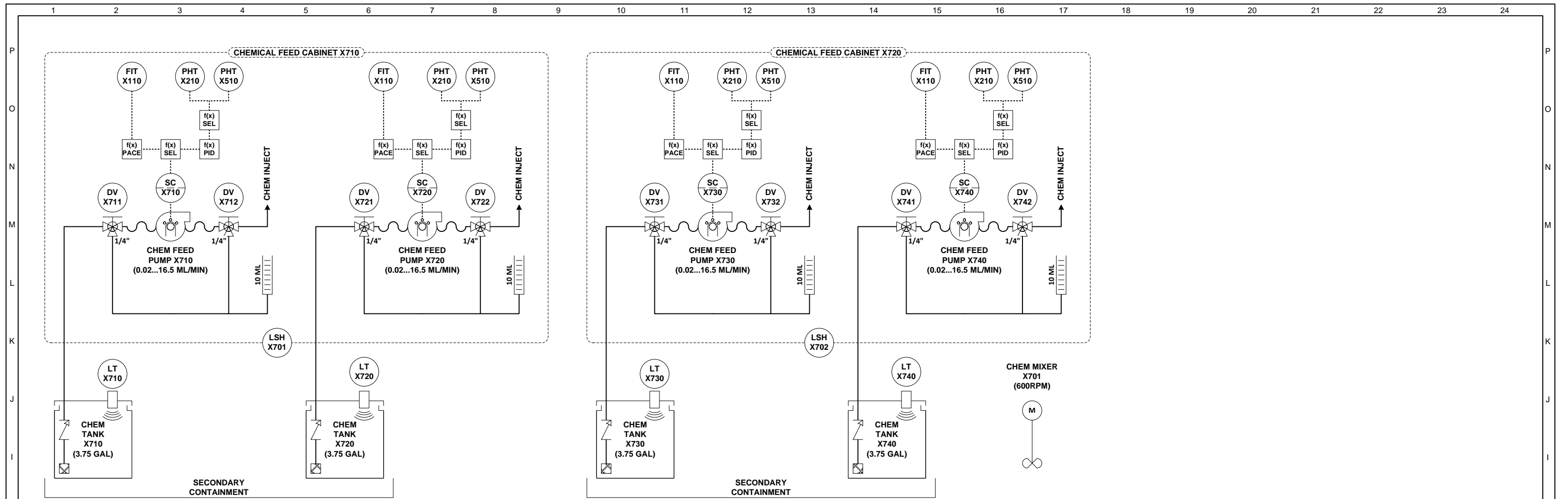
TITLE: FLOCCULATION & SEDIMENTATION MODULE S09533224-10PC-2TU-2PH-4CF-1CM	
PROCESS & INSTRUMENTATION DIAGRAM - PROCESS	
CLIENT: INTUITECH	PROJECT: NEW BUILD
DRAWN BY: AJB	DRAWN DATE: 07-08-25
DRAWING NAME: 1684-X0PP-01	P.O.:
SCALE: NONE	REVISION: 1



REV	DATE	BY	DESCRIPTION
1			
2			
3			
4			

www.intuitech.com

THIS DRAWING IS THE INTELLECTUAL PROPERTY OF INTUITECH AND
 MAY NOT BE REPRODUCED IN FULL OR IN PART FOR ANY PURPOSE
 ASIDE FROM THE PROJECT AS SPECIFIED ON THIS DOCUMENT

DIMENSIONAL TOLERANCES ARE AS FOLLOWS, UNLESS OTHERWISE SPECIFIED
 FRAC: ± 1/16 0.XX: ± 0.01
 ANGLES: ± 1° 0.XXX: ± 0.005

TITLE: FLOCCULATION & SEDIMENTATION MODULE S09533224-10PC-2TU-2PH-4CF-1CM PROCESS & INSTRUMENTATION DIAGRAM - CHEMICAL	
CLIENT: INTUITECH	PROJECT: NEW BUILD
DRAWN BY: AJB	DRAWN DATE: 07-08-25
DRAWING NAME: 1684-X0PP-02	P.O.:
SCALE: NONE	REVISION: 0

1	2	3	4	5	6	7	8	9	10	11	12	13	14	15	16	17	18	19	20	21	22	23	24
DEVICE SYMBOLS				INSTRUMENTATION				PROCESS EQUIPMENT				PUMPS/BLOWERS				VALVES				CONTROL PHILOSOPHY			
FIELD MOUNTED DEVICE ENCLOSURE MOUNTED DEVICE BACKPLANE MOUNTED DEVICE PROGRAMMABLE OPERATOR INTERFACE (ENCLOSURE MOUNTED) PROGRAMMABLE LOGIC CONTROLLER (BACKPLANE MOUNTED)				VARIABLE AREA FLOWMETER PADDLE WHEEL/ TURBINE FLOWMETER MAGNETIC FLOWMETER LAMINAR FLOWMETER VORTEX SHEDDING FLOWMETER THERMAL DISPERSION FLOWMETER ULTRASONIC LEVEL DEVICE OPTICAL DISTANCE TRANSMITTER FLOAT LEVEL DEVICE SIGHT LEVEL DEVICE GUIDED WAVE RADAR LEVEL DEVICE PRESSURE DEVICE CAPACITIVE LEVEL DEVICE				ELECTRIC MIXER HEAT EXCHANGER HEATER STATIC MIXER PIPE WEIR WITH AIR BREAK EDUCTOR FILTER / STRAINER COALESCING FILTER ORIFICE PLATE RUPTURE DISK PRESSURE GAUGE ISOLATOR PIPE REDUCER FLOW THROUGH CELL INSPECTION LIGHT				BLOWER CENTRIFUGAL PUMP DIAPHRAGM PUMP FLEXIBLE IMPELLER PUMP BI-DIRECTIONAL FLEXIBLE IMPELLER PUMP PERISTALTIC PUMP PROGRESSIVE CAVITY PUMP ROTARY LOBE PUMP GEAR PUMP COMPRESSOR				NEEDLE VALVE BUTTERFLY VALVE BALL VALVE CHECK VALVE GLOBE VALVE DIAPHRAGM VALVE GATE VALVE 3-WAY BALL VALVE 3-WAY GENERAL VALVE PLUG VALVE GENERAL VALVE AIR RELIEF VALVE VACUUM RELIEF VALVE PRESSURE / SAFETY RELIEF VALVE				SEQUENCER STEP DECISION OPERATOR INPUT PROCESS REFERENCE TO A DIFFERENT PAGE IF CONDITION IS TRUE CONTINUE			
MISCELLANEOUS																							
MINOR PROCESS LINE MAJOR PROCESS LINE ELECTRICAL SIGNAL WATER SURFACE DOUBLE WALL PIPE MAJOR ARROW MINOR ARROW PROCESS VALUE POINT DRAIN WITH AIR BREAK PROCESS BOUNDARY CONDUIT SEAL-OFF																							
												CONTROL FUNCTIONS											
												PROPORTIONAL, INTEGRAL & DERIVATIVE FLOW PACING SUBTRACTION PULSE WIDTH MODULATION CALCULATION SELECTION SUMMATION MULTIPLEXER TRIM SET POINT LIMITING											
																ACTUATORS							
																PRESSURE REGULATING ACTUATOR AIR-TO-OPEN/ SPRING TO CLOSE ACTUATOR AIR-TO-OPEN/ AIR-TO-CLOSE ACTUATOR AIR-TO-CLOSE/ SPRING-TO-OPEN ACTUATOR ELECTRIC ACTUATOR SOLENOID ACTUATOR HAND ACTUATOR LEVEL ACTUATOR							

REV	DATE	BY	DESCRIPTION
1			
2			
3			
4			

Intuitech
www.intuitech.com

THIS DRAWING IS THE INTELLECTUAL PROPERTY OF INTUITECH AND MAY NOT BE REPRODUCED IN FULL OR IN PART FOR ANY PURPOSE ASIDE FROM THE PROJECT AS SPECIFIED ON THIS DOCUMENT

DIMENSIONAL TOLERANCES ARE AS FOLLOWS, UNLESS OTHERWISE SPECIFIED

FRAC: ± 1/16 0.XX: ± 0.01
 ANGLES: ± 1° 0.XXX: ± 0.005

TITLE: PROCESS & INSTRUMENTATION DIAGRAM SYMBOL LEGEND	
CLIENT:	PROJECT:
DRAWN BY:	DRAWN DATE:
DRAWING NAME: 0000-XXRL-01.VSD	P.O.:
SCALE: NONE	REVISION:

INPUT DEVICE TAG PREFIXES						
PARAMETER	ELEMENT / SENSOR	INDICATOR	TRANSMITTER		SWITCH	
			BLIND	INDICATING	HIGH	LOW
AMMONIUM	AME	AMI	AMT	AMIT	AMSH	AMSL
ANALYTICAL (UNSPECIFIED)	AE	AI	AT	AIT	ASH	ASL
CHLORINE	CHE	CHI	CHT	CHIT	CHSH	CHSL
TOTAL CHLORINE	TCHE	TCHI	TCHT	TCHIT	TCHSH	TCHSL
CONDUCTIVITY	CE	CI	CT	CIT	CSH	CSL
CURRENT	CUE	CUI	CUT	CUIT	CUSH	CUSL
DISSOLVED OXYGEN	DOE	DOI	DOT	DOIT	DOSH	DOSL
FLOW RATE	FE	FI	FT	FIT	FSH	FSL
FLOW TOTALIZER	FQE	FQI	FQT	FQIT	FQSH	FQSL
HARDNESS	HE	HI	HT	HIT	HSH	HSL
HYDROGEN SULFIDE	HSE	HSI	HST	HSIT	HSSH	HSSL
LEVEL	LE	LI	LT	LIT	LSH	LSL
LOWER EXPLOSION LIMIT	LELE	LELI	LELT	LELIT	LELH	LELL
NITROGEN	NE	NI	NT	NIT	NSH	NSL
ORP	ORE	ORI	ORT	ORIT	ORSH	ORSL
OXYGEN	OXE	OXI	OXT	OXIT	OXSH	OXSL
OZONE	OZE	OZI	OZT	OZIT	OZSH	OZSL
PARTICLE	PCE	PCI	PCT	PCIT	PCSH	PCSL
PH	PHE	PHI	PHT	PHIT	PHSH	PHSL
POSITION	ZE	ZI	ZT	ZIT	ZSH	ZSL
POWER	PWE	PWI	PWT	PWIT	PWSH	PWSL
POWER TOTALIZER	PWQE	PWQI	PWQT	PWQIT	PWQSH	PWQSL
PRESSURE	PE	PI	PT	PIT	PSH	PSL
PRESSURE DIFFERENTIAL	PDE	PDI	PDT	PDIT	PDSH	PDSL
RESISTIVITY	RE	RI	RT	RIT	RSH	RSL
RELATIVE HUMIDITY	RHE	RHI	RHT	RHIT	RHSH	RHSL
SPEED	SE	SI	ST	SIT	SSH	SSL
STREAMING CURRENT	SCE	SCI	SCT	SCIT	SCSH	SCSL
SUSPENDED SOLIDS	SSE	SSI	SST	SSIT	SSSH	SSSL
TEMPERATURE	TE	TI	TT	TIT	TSH	TSL
TIME TOTALIZER	TQE	TQI	TQT	TQIT	TQSH	TQSL
TOTAL ORGANIC CARBON	TCE	TCI	TCT	TCIT	TCSH	TCSL
TURBIDITY	TUE	TUI	TUT	TUIT	TUSH	TUSL
UV ABSORPTION OR TRANSMITTANCE	UVE	UVI	UVT	UVIT	UVSH	UVSL
VOLTAGE	VE	VI	VT	VIT	VSH	VSL
WEIGHT / FORCE	WE	WI	WT	WIT	WSH	WSL

ALARM DEVICE TAG PREFIXES		
PARAMETER	HIGH	LOW
AMMONIUM	AMAH	AMAL
ANALYTICAL (UNSPECIFIED)	AAH	AAL
CHLORINE	CHAH	CHAL
TOTAL CHLORINE	TCHAH	TCHAL
CONDUCTIVITY	CAH	CAL
CURRENT	CUAH	CUAL
DISSOLVED OXYGEN	DOAH	DOAL
FLOW RATE	FAH	FAL
FLOW TOTALIZER	FQAH	FQAL
HARDNESS	HAH	HAL
HYDROGEN SULFIDE	HSAH	HSAL
LEVEL	LAH	LAL
LOWER EXPLOSION LIMIT	LELH	LELL
NITROGEN	NAH	NAL
OXYGEN	OXAH	OXAL
OZONE	OZAH	OZAL
PARTICLE	PCAH	PCAL
PH	PAH	PAL
POWER	PWAH	PWAL
POWER TOTALIZER	PWQAH	PWQAL
PRESSURE	PAH	PAL
PRESSURE DIFFERENTIAL	PDAH	PDAL
RESISTIVITY	RAH	RAL
RELATIVE HUMIDITY	RHAH	RHAL
SPEED	SAH	SAL
STREAMING CURRENT	SCAH	SCAL
SUSPENDED SOLIDS	SSAH	SSAL
TEMPERATURE	TAH	TAL
TIME TOTALIZER	TQAH	TQAL
TOTAL ORGANIC CARBON	TCAH	TCAL
TURBIDITY	TUAH	TUAL
UV ABSORPTION	UVAH	UVAL
VOLTAGE	VAH	VAL
WEIGHT / FORCE	WAH	WAL

OUTPUT DEVICE TAG PREFIXES	
DESCRIPTION	TAG
CHECK VALVE	CV
DISCRETE VALVE (OPEN/CLOSED)	DV
INJECTION VALVE	IV
PILOT VALVE	YV
PRESSURE REGULATOR	PR
PROPORTIONAL VALVE (MODULATING)	PV
RELIEF VALVE	RV
SAMPLE VALVE	SV

CONTROL DEVICE TAG PREFIXES	
DESCRIPTION	TAG
FLOW CONTROLLER	FC
FLOW INDICATING CONTROLLER	FIC
PRESSURE CONTROLLER	PC
PRESSURE INDICATING CONTROLLER	PIC
SPEED CONTROLLER	SC
SPEED INDICATING CONTROLLER (VFD)	SIC
TEMPERATURE CONTROLLER	TC
TEMPERATURE INDICATING CONTROLLER	TIC

REV	DATE	BY	DESCRIPTION
1			
2			
3			
4			











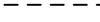

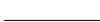





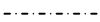



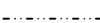

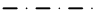

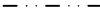

















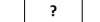



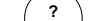

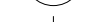

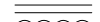







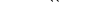



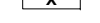

THIS DRAWING IS THE INTELLECTUAL PROPERTY OF INTUITECH AND MAY NOT BE REPRODUCED IN FULL OR IN PART FOR ANY PURPOSE ASIDE FROM THE PROJECT AS SPECIFIED ON THIS DOCUMENT

DIMENSIONAL TOLERANCES ARE AS FOLLOWS, UNLESS OTHERWISE SPECIFIED
 FRAC: ± 1/16 0.XX: ± 0.01
 ANGLES: ± 1° 0.XXX: ± 0.005

TITLE: DEVICE TAG LEGEND	
CLIENT:	PROJECT:
DRAWN BY:	DRAWN DATE:
DRAWING NAME: 0000-XXRL-02.VSD	P.O.:
SCALE: NONE	REVISION: 0

ELECTRICAL

	WIRING PROVIDED BY OTHERS		RESISTOR
	INTERNAL WIRING OR COMPONENTS		VARISTOR
	NON-WIRE JUMPERS		CAPACITOR
	STRANDED COPPER WIRE		HAND-OFF-AUTO SWITCH
	TWISTED PAIR CABLE WITH SHIELD & DRAIN		TWO POSITION SWITCH
	MOLDED CABLE		FLOW SWITCH
	SPECIAL CABLE		LIQUID LEVEL SWITCH
	INTEGRAL CABLE		TEMPERATURE SWITCH
	CAT5E CABLE		NORMALLY OPEN PUSH-BUTTON
	CAT5E CABLE		NORMALLY CLOSED PUSH-BUTTON
	CAT5E CABLE		LINE REACTOR
	CAT5E CABLE		SIGNAL POLE SWITCH
	CAT5E CABLE		PRESSURE SWITCH
	CAT5E CABLE		WIRELESS LINK
	CAT5E CABLE		VARIABLE FREQUENCY DRIVE
	CAT5E CABLE		SEAL-OFF CONNECTOR
	CAT5E CABLE		SURGE PROTECTION DEVICE
	CAT5E CABLE		LOAD
	CAT5E CABLE		MOTOR
	CAT5E CABLE		TRANSFORMER
	CAT5E CABLE		SHIELD
	CAT5E CABLE		PLUG CONNECTOR
	CAT5E CABLE		INLINE CONNECTOR (SPLICE, WIRE NUT, ETC)
	CAT5E CABLE		GROUND
	CAT5E CABLE		TERMINAL
	CAT5E CABLE		COIL
	CAT5E CABLE		LIGHT WITH COLOR
	CAT5E CABLE		CIRCUIT BREAKER
	CAT5E CABLE		FUSE
	CAT5E CABLE		NORMALLY OPEN CONTACT
	CAT5E CABLE		NORMALLY CLOSED CONTACT
	CAT5E CABLE		OVERLOAD RELAY

REV	DATE	BY	DESCRIPTION
1			
2			
3			
4			



www.intuitech.com

THIS DRAWING IS THE INTELLECTUAL PROPERTY OF INTUITECH AND MAY NOT BE REPRODUCED IN FULL OR IN PART FOR ANY PURPOSE ASIDE FROM THE PROJECT AS SPECIFIED ON THIS DOCUMENT

DIMENSIONAL TOLERANCES ARE AS FOLLOWS, UNLESS OTHERWISE SPECIFIED

FRAC: ± 1/16	0.XX: ± 0.01
ANGLES: ± 1°	0.XXX: ± 0.005

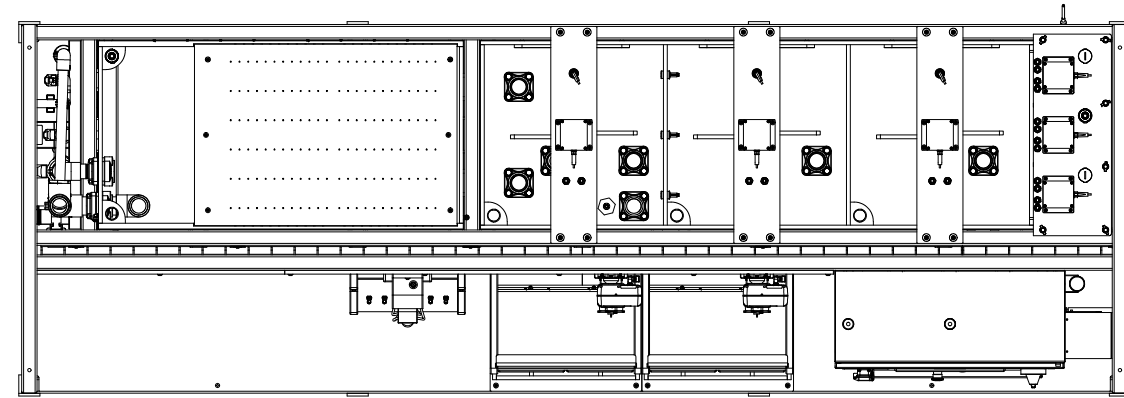
TITLE: ELECTRICAL SYMBOL LEGEND	
CLIENT:	PROJECT:
DRAWN BY:	DRAWN DATE:
DRAWING NAME: 0000-XXRL-03.VSD	P.O.:
SCALE: NONE	REVISION: 0



TOP VIEW

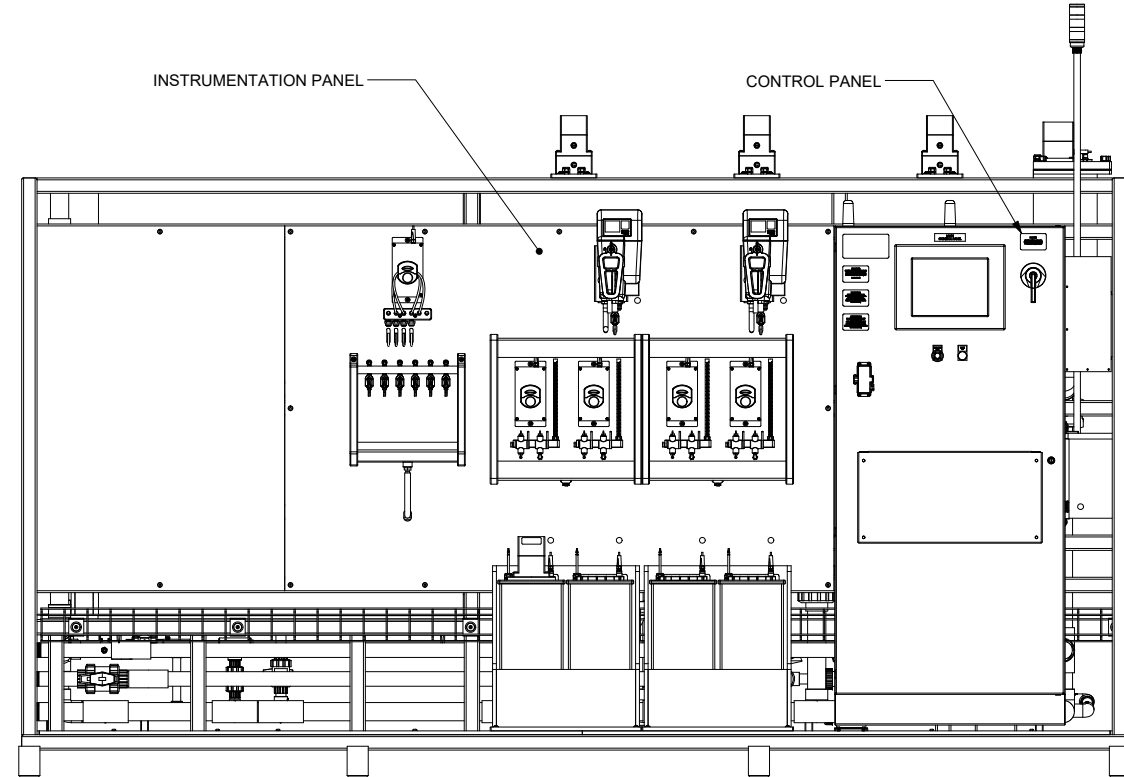

BACK VIEW

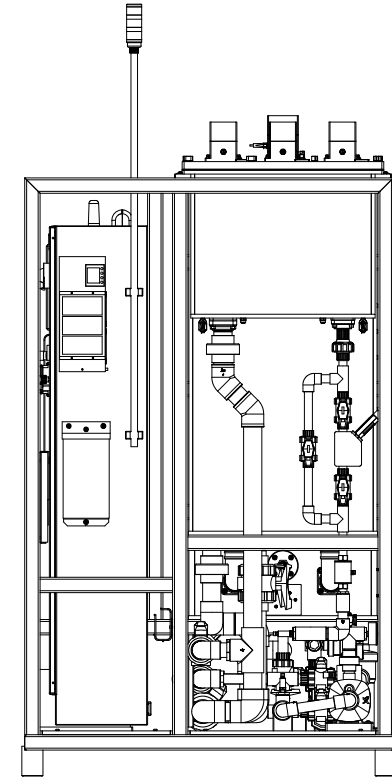

RIGHT VIEW

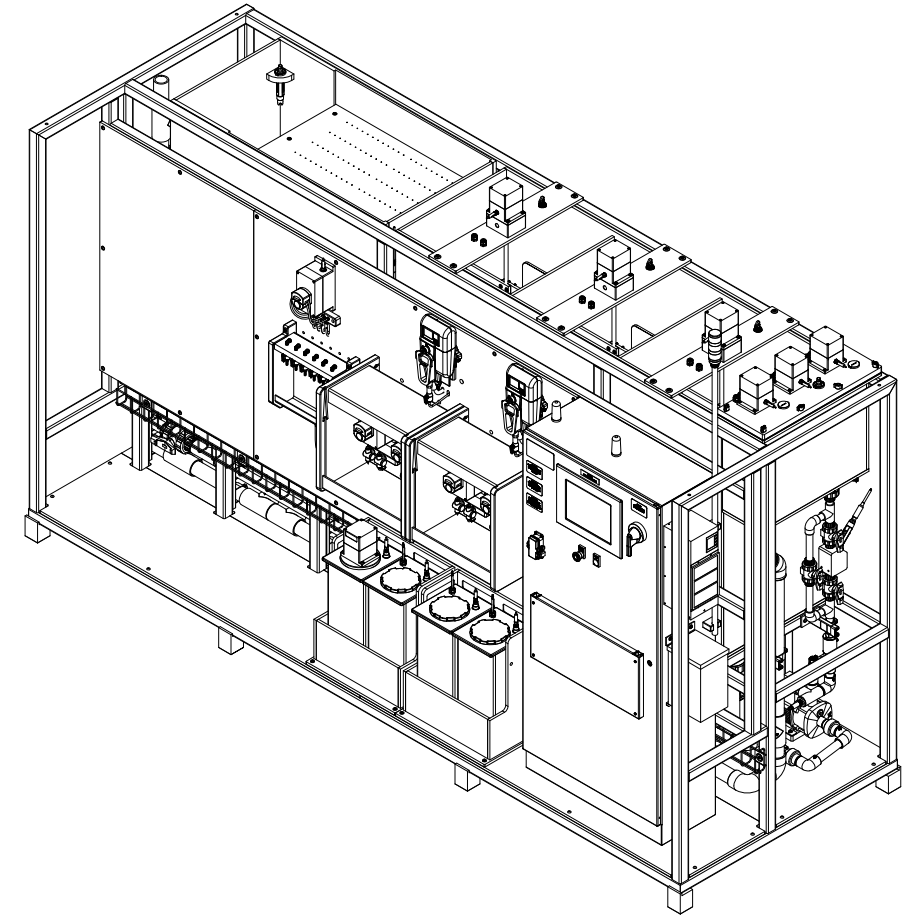

REV	DATE	BY	CHECKED	DESCRIPTION
1				
2				
3				
4				

www.intuitech.com

THIS DRAWING IS THE INTELLECTUAL PROPERTY OF INTUITECH AND MAY NOT BE REPRODUCED IN FULL OR IN PART FOR ANY PURPOSE ASIDE FROM THE PROJECT SPECIFIED ON THIS DOCUMENT

DIMENSIONAL TOLERANCES ARE AS FOLLOWS UNLESS OTHERWISE SPECIFIED
 FRAC: ±1/16 0.XX: ±0.01
 ANGLES: ±1° 0.XXX: ±0.005

TITLE: FLOCCULATION & SEDIMENTATION MODULE - S700 FLOCCULATION SEDIMENTATION MODULE - GENERAL ARRANGEMENT	
CLIENT: INTUITECH	PROJECT: 1794
DRAWN BY: DGW	DRAWN DATE: 07/08/25
DRAWING NAME: 1684-X0GA-02	P.O.:
SCALE: NONE	REVISION: 0

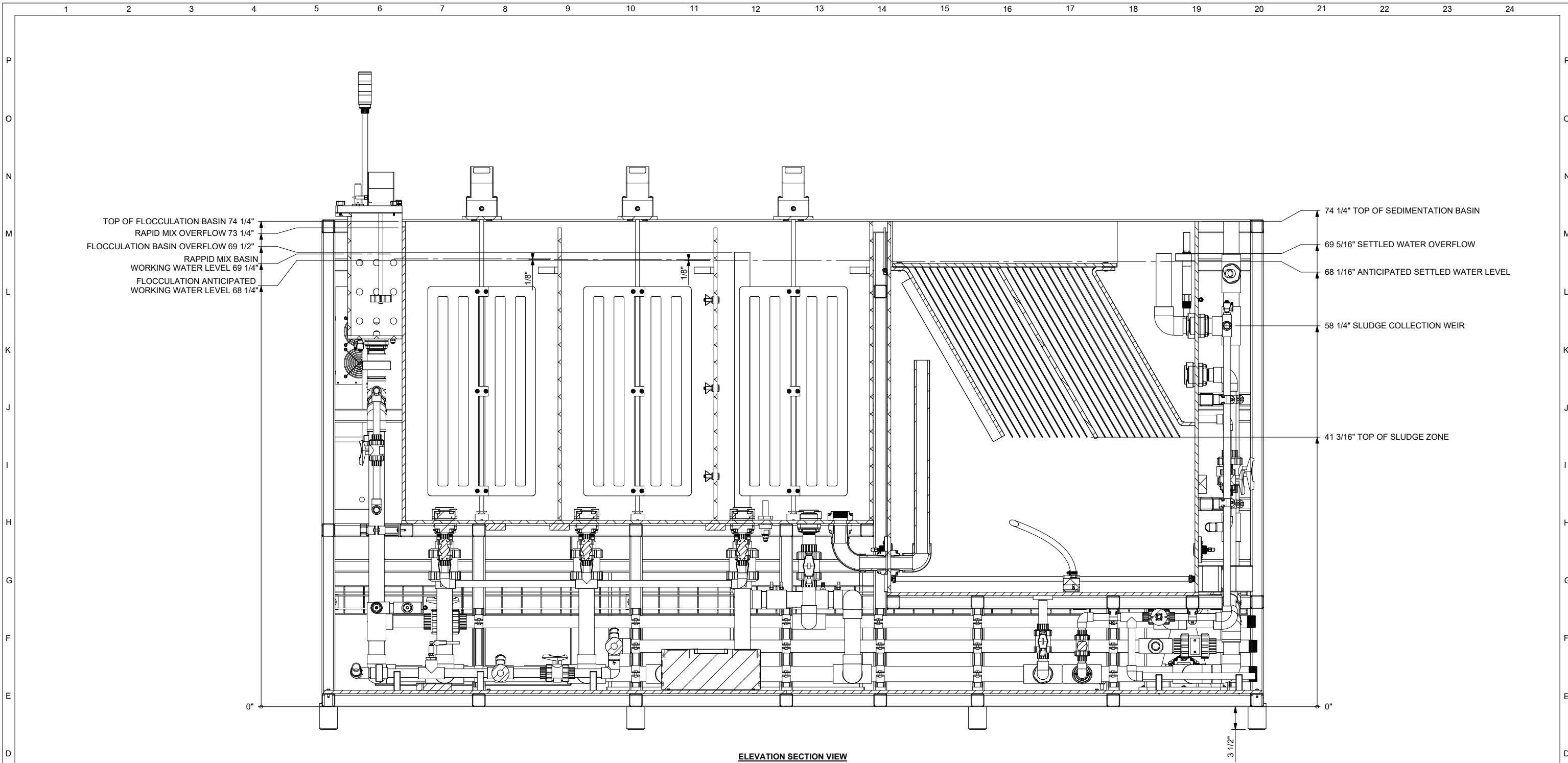

ELEVATION SECTION VIEW

REV	DATE	BY	CHECKED	DESCRIPTION
1				
2				
3				
4				

 www.intuitech.com

THIS DRAWING IS THE INTELLECTUAL PROPERTY OF INTUITECH AND MAY NOT BE REPRODUCED IN FULL OR IN PART FOR ANY PURPOSE ASIDE FROM THE PROJECT SPECIFIED ON THIS DOCUMENT

DIMENSIONAL TOLERANCES ARE AS FOLLOWS UNLESS OTHERWISE SPECIFIED
 FRAC: ±1/16 0.XX: ±0.01
 ANGLES: ±1° 0.XXX: ±0.005

TITLE: FLOCCULATION & SEDIMENTATION MODULE - S700	
FLOCCULATION SEDIMENTATION MODULE - ELEVATION	
CLIENT: INTUITECH	PROJECT: 1794
DRAWN BY: DGW	DRAWN DATE: 07/08/25
DRAWING NAME: 1684-X0GA-03	P.O.:
SCALE: NONE	REVISION: 0

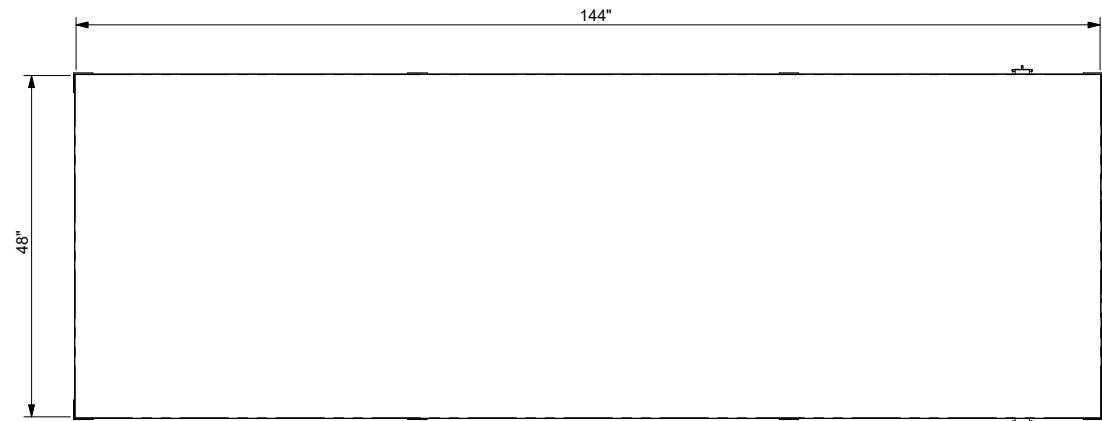

TOP VIEW

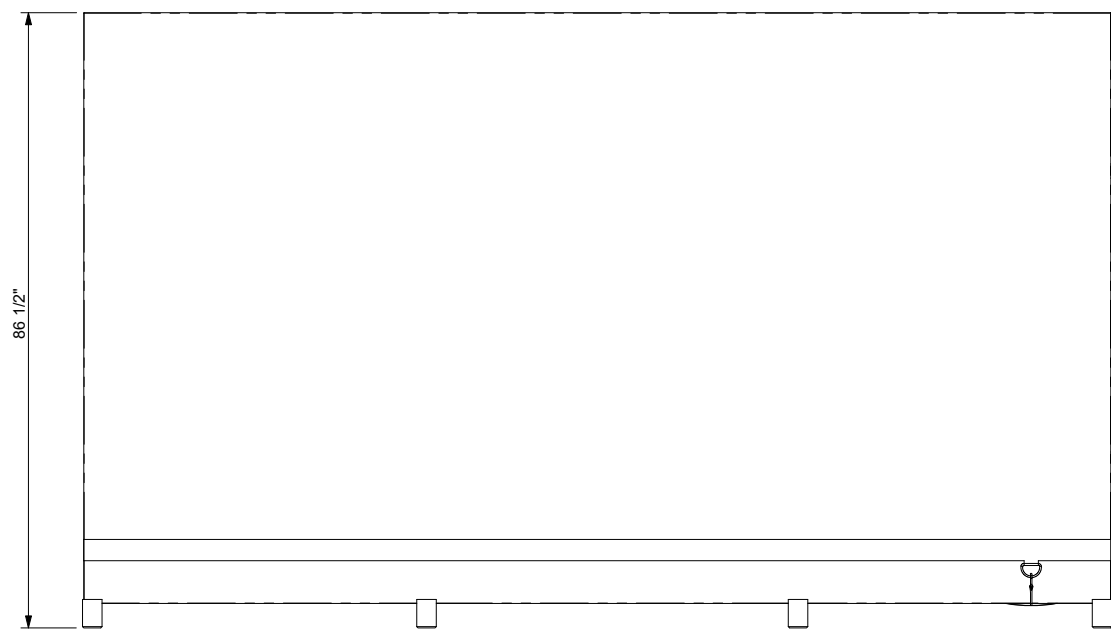
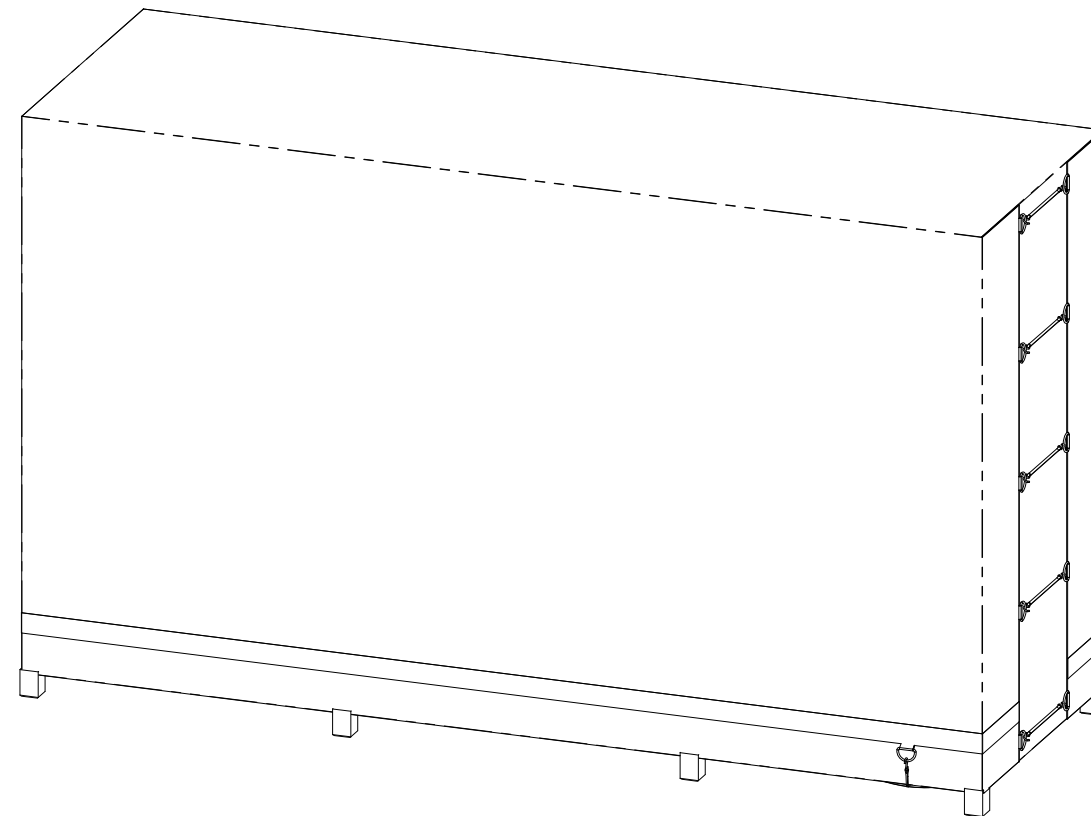

FRONT VIEW

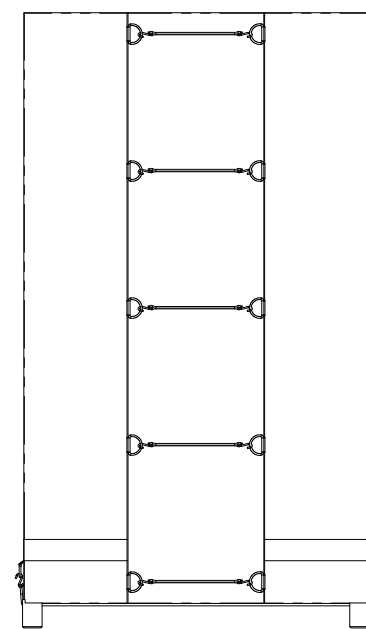

RIGHT VIEW

REV	DATE	BY	CHECKED	DESCRIPTION
1				
2				
3				
4				



THIS DRAWING IS THE INTELLECTUAL PROPERTY OF INTUITECH AND MAY NOT BE REPRODUCED IN FULL OR IN PART FOR ANY PURPOSE ASIDE FROM THE PROJECT SPECIFIED ON THIS DOCUMENT

DIMENSIONAL TOLERANCES ARE AS FOLLOWS UNLESS OTHERWISE SPECIFIED

FRAC: $\pm 1/16$ 0.XX: ± 0.01
 ANGLES: $\pm 1^\circ$ 0.XXX: ± 0.005

TITLE: FLOCCULATION & SEDIMENTATION MODULE - S700 FLOCCULATION SEDIMENTATION MODULE - SHIPPING	
CLIENT: INTUITECH	PROJECT: 1794
DRAWN BY: DGW	DRAWN DATE: 07/08/25
DRAWING NAME: 1684-X0GA-04	P.O.:
SCALE: NONE	REVISION: 0

SUPPLY VOLTAGE:
 120VAC, 1PHASE, 60HZ, 20A OR
 240VAC, 1PHASE, 60HZ, 10 FLA
 SCCR 10KA

POWER CORD 12AWG,
 25 FT, NOTE 2

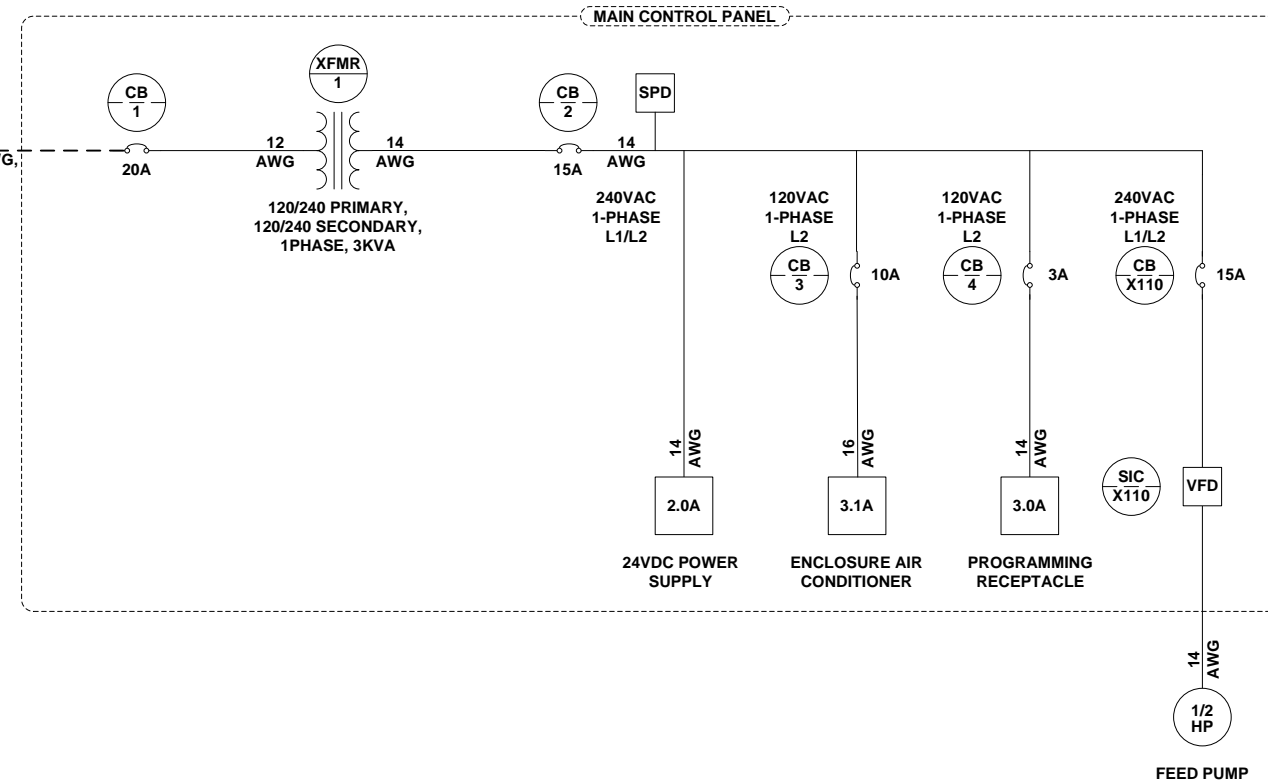

NOTES:

1. THE AVAILABLE SHORT CIRCUIT CURRENT SUPPLIED TO THIS EQUIPMENT SHALL NOT EXCEED THE MARKED SHORTCIRCUIT CURRENT RATING (SCCR) OF THIS EQUIPMENT
2. NEMA 5-20P (120 VAC) OR NEMA 6-15 (240 VAC)

REV	DATE	BY	DESCRIPTION
1			
2			
3			
4			



THIS DRAWING IS THE INTELLECTUAL PROPERTY OF INTUITECH AND MAY NOT BE REPRODUCED IN FULL OR IN PART FOR ANY PURPOSE ASIDE FROM THE PROJECT AS SPECIFIED ON THIS DOCUMENT

DIMENSIONAL TOLERANCES ARE AS FOLLOWS, UNLESS OTHERWISE SPECIFIED

FRAC: ± 1/16 0.XX: ± 0.01
 ANGLES: ± 1° 0.XXX: ± 0.005

TITLE: FLOC/SED MODULE S700 MAIN CONTROL PANEL ONE LINE DIAGRAM	
CLIENT: INTUITECH	PROJECT: 1794
DRAWN BY: BNL	DRAWN DATE: 07/08/25
DRAWING NAME: 1684-X0LD-01	P.O.:
SCALE: NONE	REVISION: 0